

Mr. SLIM

INVERTER
TECHNOLOGY

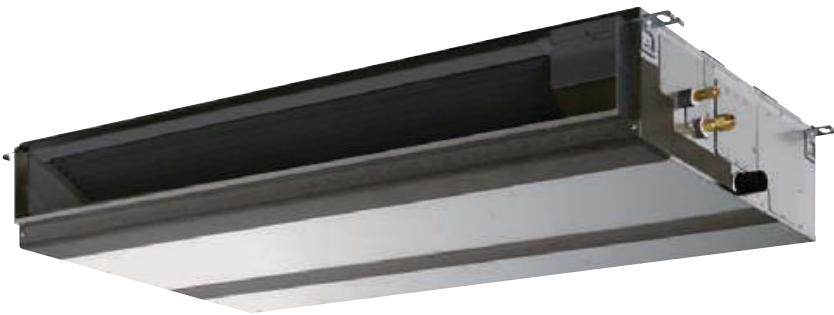

PEY-P18/24/30/36/45JAG



PEY-P60GAG

TROPICAL

The MEQ Difference

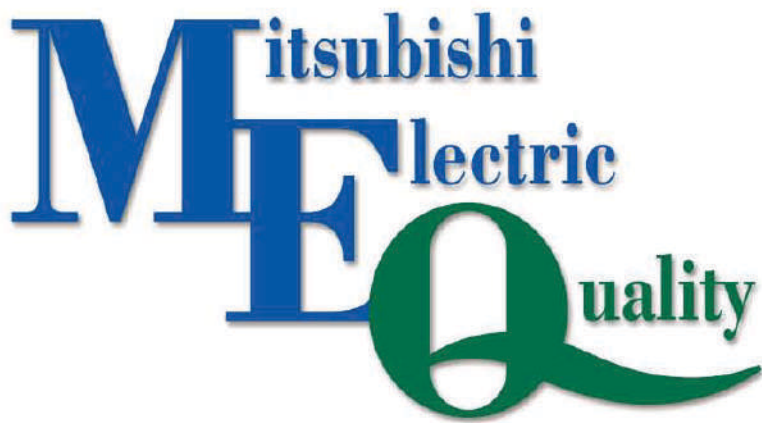

Simply meeting industry standards, however stringent, is not enough. Our aim is to exceed them. When it comes to comfort, efficiency and durability, Mitsubishi Electric offers you a distinctive advantage. We call it MEQ — Mitsubishi Electric Quality. It results in benchmark leading-edge products like our air conditioners, which consume minimal power, protect your investment through a long service life, offer superior reliability and are built to take the punishment of extreme weather conditions year in and year out.

Mitsubishi Electric Offers Three Important Advantages

Comfort

Clean air, optimum temperature distribution and silent operation...

MEQ has led to the development of state-of-the-art air purification and deodorization filters that remove unwanted odors and impurities in the air. Original airflow technologies and specially designed components provide even temperature distribution even in remote regions of a room. At Mitsubishi Electric, comfort doesn't simply mean cool or warm, it means clean and quiet too.

Efficiency

Optimum cost performance and energy savings...

MEQ results in air conditioners that are rated among the best in the industry in terms of quality and energy efficiency. We strive for a perfect balance of performance, reliability, low power consumption and long service life. This is complemented by continuously introducing new technologies and components that further reduce energy requirements and negative environmental impact.

Durability

Rugged construction, rigorous testing, long-lasting operation...

MEQ is behind a mindset that goes to extremes to ensure higher quality products that protect the initial investment over years of reliable service. We subject our indoor and outdoor units to rigorous durability testing, including harsher temperature extremes than likely found anywhere in the world.

Doing Our Part to Create a Better Future for All

Core Environmental Policy

Mitsubishi Electric promotes sustainable development, and is committed to protecting and restoring the global environment through technology, all of its business activities and the actions of its employees.

R 410A refrigerant

As scientific evidence points to man-made chemicals for the damage caused to the ozone layer, we only use chlorine-free refrigerants that are safe and rated zero ODP (Ozone Depletion Potential). Accordingly, our systems require less energy to run and have a significantly lower indirect global warming potential. In short, we produce the most efficient equipment possible, while helping to protect the environment.

The Montreal Protocol calls for the complete abolishment of HCFC (such as R22) refrigerant production by the year 2020.

Mitsubishi Electric is committed to shifting over to HFC models from HCFC models.

Montreal Protocol

Montreal Protocol regulates HCFCs

- HCFC production has been regulated since 2004.
- HCFCs will be entirely banned by 2020.

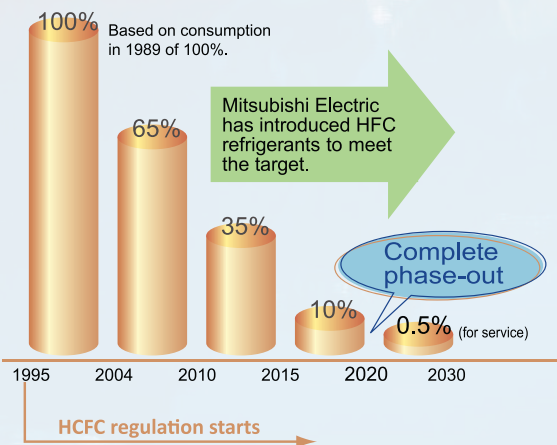

Mechanism of ozone layer depletion by HCFCs

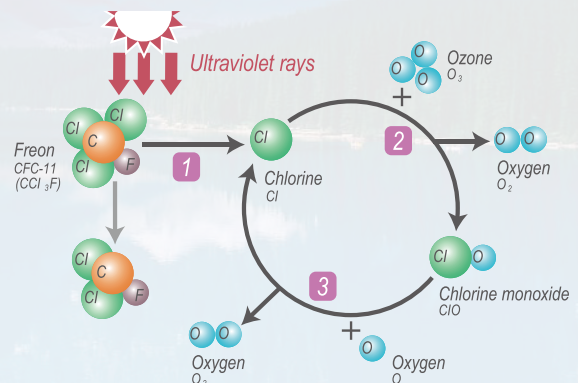

- 1 UV radiation causes CFC molecules to breakdown and release chlorine atoms.
- 2 Ozone molecules react with chlorine atoms and are broken down into oxygen atoms and chlorine monoxide.
- 3 Oxygen atoms react with chlorine monoxide to form oxygen molecules and chlorine atoms.

Chlorine atoms react with ozone molecules again. This repetition continues, depleting the ozone layer.

HFC refrigerants do not contain chlorine, the causative agent of ozone layer depletion, which HCFC refrigerants contain. Therefore, Mitsubishi Electric has shifted over to HFC (R410A) refrigerants from HCFC (R22) refrigerants.

Ceiling Concealed

The thin, ceiling-concealed indoor units of the PEY series are the perfect answer for the air conditioning requirements of buildings with minimum ceiling installation space and wide ranging external static pressure. Energy-saving efficiency has been improved, thereby reducing electricity consumption and contributing to a further reduction in operating cost.

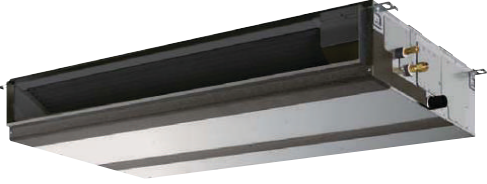

PEY-P18/24/30/36/45JAG



PEY-P60GAG

The thin, ceiling-concealed indoor units of PEY-P-JAG are the perfect answer for the air conditioning requirements of buildings with minimum ceiling installation space and wide-ranging external static pressure. Energy-saving efficiency has been improved, thereby reducing electricity consumption and contributing to a further reduction in operating cost.

For elegance and compact style, PEY-P-GAG compliments the room environment with an aesthetically pleasing ceiling installation and a vast line-up of performance functions.

Flexible duct design

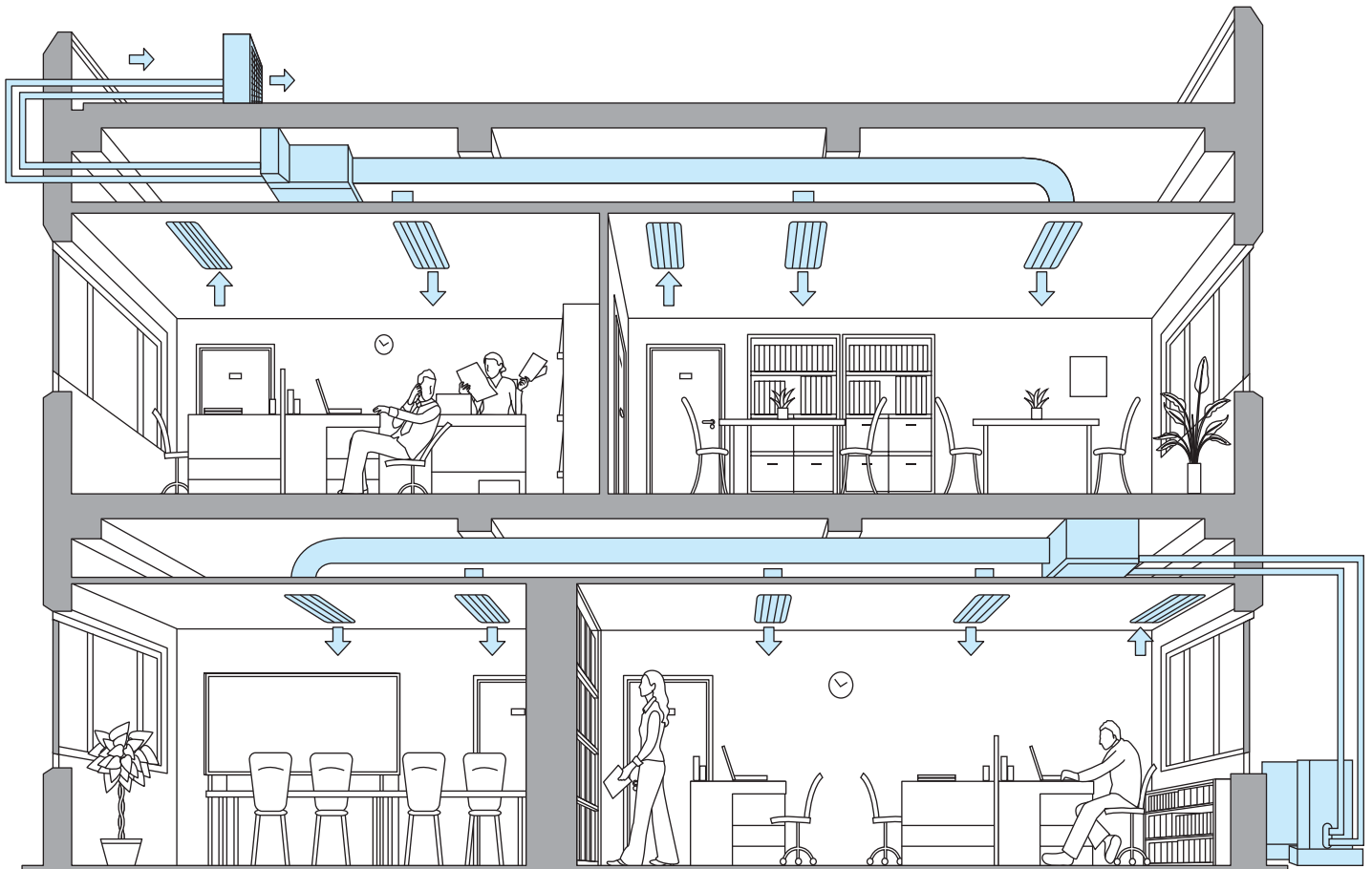

Inverter technologies

INVERTERS – HOW THEY WORK

Inverters electronically control the electrical voltage, current and frequency of electrical devices such as the compressor motor in an air conditioner. They receive information from sensors monitoring operating conditions and adjust the rotation speed of the compressor, which directly regulates air conditioner output. Optimum control of operation frequency results in eliminating the consumption of excessive electricity and providing the most comfortable room environment.

ECONOMIC OPERATION

Impressively low operating cost is a key advantage of inverter air conditioners. We've combined advanced inverter technologies with cutting-edge electronic and mechanical technologies to achieve a synergistic effect that enables improvements in cooling performance efficiency. Better performance and lower energy consumption are the result.

TRUE COMFORT

Below is a simple comparison of air conditioner operation control with and without an inverter.

Inverter operation comparison

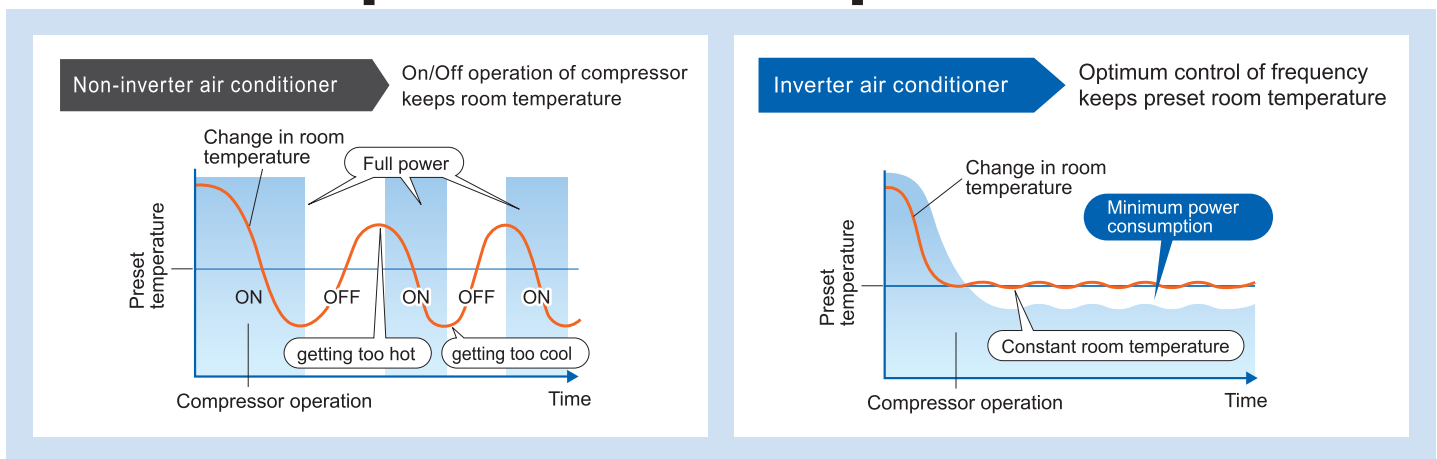

The compressors of air conditioners without an inverter start and stop repeatedly in order to maintain the preset room temperature. This repetitive on/off operation uses excessive electricity and compromises room comfort. The compressors of air conditioners equipped with an inverter run continuously; the inverter quickly optimizing the operating frequency according to changes in room temperature. This ensures energy-efficient operation and a more comfortable room.

Wide Selection of Fan Speeds and External Static Pressure

Five-stage external static pressure conversions and three fan speed *1 selections are available. Capable of being set to a maximum of 150Pa *2, units are applicable to a wide range of building types.

*1 PEY-P18/24/30/36/45JAG *2 PEY-60GAG

External static pressure setting

PEY-P18/24/30/36/45JAG	35/50/70/100/125Pa
PEY-P60GAG	50/100/150Pa

Operating at 52°C temperature

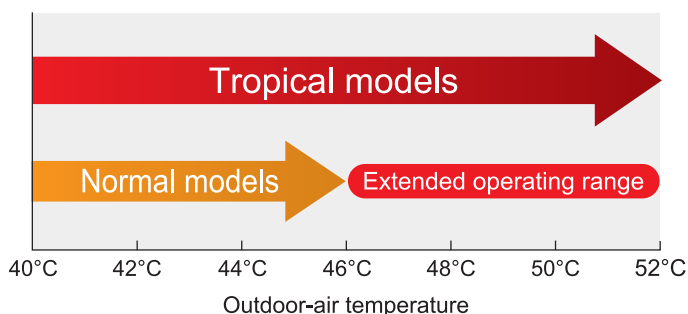

Mitsubishi Electric introduces a new tropical specifications series. New technologies which are used for the component of air-conditioners ~ a key component of air-conditioners has made it possible for units to operate at outdoor-air temperatures as high as 52°C. The new tropical specification series units are perfect for cooling homes in tropical regions.

Mechanical Specifications

1. General

All units are consisting of a ceiling concealed type indoor unit (evaporating unit), an outdoor unit and a wall mounted remote controller and are factory assembled with fully charged R-410A refrigerant. They are also tested and checked under a strict quality control system in the factory. The units can be easily connected together with refrigerant pipe and the control can be wired in the field.

2. Indoor Units (Evaporating Units)

Casing

All panels are made of 1 mm thick galvanized steel with thermal insulated.

Drain Pan

Each unit has a hard plastic drain pan to cover entire length of cooling coil with positive drainage construction. It has a 32mm OD male drain connection.

Evaporators Coils

Coils are made of 7.0mm OD and 0.23mm thick seamless copper tubing with inner grooved mechanically bonded aluminum plate fins and are factory leak tested at maximum pressure of 3.63MPa and 3 times higher than maximum pressure holding 1min. for strength test.

Evaporators Fans

Direct driven, forward curved centrifugal type fans are used to deliver an accurate airflow at low noise level. Fan driving components are mounted on rubber pad isolators to reduce noise and vibration.

Computerized Dehumidification

The electronic dehumidifier mode - where fan speed is controlled precisely - increases dehumidification volume while improving dehumidifying efficiency

3. Outdoor Units (Condensing Units)

Casing

All condensing units casing is 0.8mm thick Zinc coated alloy steel coated with polyester resin paint and it is passed factory salt spray test based on JIS Z 2371. Mounting base made of Zinc alloy steel with acrylic/polyester coating against corrosion.

Compressor

All condensing units have high efficiency inverter type compressors equipped with thermal protections. Compressor mounted on rubber anti vibrating isolators.

Condenser Coils

Coils are made of 7.0mm OD and 0.23mm thick seamless copper tubing with inner grooved mechanically bonded aluminum plate fins and are factory leak tested at maximum pressure of 4.12MPa and 3 times higher than maximum pressure holding 1min. for strength test.

Condenser Fans

Molded type DC motor used to drive the condenser fan made of light plastic propeller type designed for reduce energy requirement which ensures quiet operation. Motor protected with Class E insulation and compliance with JIS (Japanese Industrial Standards). Condenser fan protected by PE coated steel fan guard.

Filter

All units have a permanent washable synthetic filter.

Room Thermostat

All units have a wall mounted electronic control wired thermostat with features such as an on-off switch, temperature setting, in-built sensors and indication pilot lamps.

Features at a glance

Installation & Maintenance	Comfort	Others
Chargeless system	Computerized Dehumidifier	System control
Smooth installation	Quiet operation	Twin-multi operation
Self-diagnostic function		Auto restart
		Outdoor unit max. operating temp. of 52°C

Specifications

PEY-Series

Ceiling Concealed (50Hz)

Models		Indoor	PEY-P18JAG	PEY-P24JAG	PEY-P30JAG	PEY-P36JAG	PEY-P45JG	PEY-P60GAG
		Outdoor	SUY-P18VA2-AE	SUY-P24VA2-AE	SUY-P30VA2-AE	SUY-P36VA2-AE	PUY-P45YKA2-AE	PUY-P60YKA2-AE
T1 Condition (*1)	Cooling Capacity (Maximum)	kW	5.4	8.9	9.7	10.7	15.0	17.6
		Btu/Hr	18,500	30,400	33,100	36,500	51,200	60,050
	Cooling Capacity (Rated)	kW	5.3	7.1	8.8	10.2	13.2	16.6
		Btu/Hr	18,084	24,225	30,026	34,802	45,038	56,639
	Total Input (Rated)	kW	1.56	2.02	2.50	3.00	4.50	6.90
	Power Factor	%	94	93	94	93	83	90
EER	W / W	3.40	3.51	3.52	3.40	2.93	2.41	
T3 Condition (*2)	Cooling Capacity (Maximum)	kW	4.5	8.1	8.6	9.2	12.5	15.0
		Btu/Hr	15,225	27,555	29,350	31,390	42,650	51,150
	Cooling Capacity (Rated)	kW	4.3	5.6	7.9	8.0	10.6	12.1
		Btu/Hr	14,672	19,107	26,955	27,296	36,167	41,300
	Total Input (Rated)	kW	1.72	2.24	3.15	3.19	4.23	4.83
	Power Factor	%	94	94	95	94	83	87
EER	W / W	2.51	2.51	2.51	2.51	2.51	2.51	
Indoor Unit								
Power Supply	50 Hz	1 Ph / 220V -230V-240V						
Rated Current	A	0.79 / 0.77 / 0.75	1.17 / 1.15 / 1.13	1.57 / 1.55 / 1.53	2.29 / 2.27 / 2.25		3.84 / 3.82 / 3.80	
External Finish		Galvanized Sheet						
Air Flow Low - Mid - High	CFM	425-510-600	620-740-885	850-1025-1200	1040-1254-1485		1695 - 2119	
	L/s	200-241-283	293-349-418	401-484-566	491-578-701		800 - 1000	
External Static Pressure	Pa	35 - 50 - 70 - 100 - 125					50 - 100 - 150	
Operation Control /Thermostat		Remote Control / Built-in						
Noise Level (Low / Mid / High) *3	dB (A)	30 - 35 - 39	30 - 34 - 39	33 - 38 - 42	36 - 40 - 44		42 - 45	
Drain Pipe (O.D)	mm	32					25.4	
Dimensions (H / W / D)	mm	250 / 900 / 732	250 / 1100 / 732	250 / 1400 / 732			400 / 1400 / 634	
Weight (Panel)	Kg	27	29	38	39		63	
Outdoor Unit								
Power Supply	50 Hz	1 Ph / 220V - 230V - 240V				3 Ph / 380V - 400V - 415V		
Rated Current (Set)	A	7.2	9.4	11.6	14.0	7.8	11.1	
External Finish		Munsell 3.0Y 7.8 / 1.1						
Refrigerant Control (R410A)		Linear Expansion Valve (LEV)						
Dimensions (H / W / D)	mm	550 / 800 / 285	880 / 840 / 330			1338 / 1050 / 330		
Weight	Kg	32	47	50	51	95	103	
Max. Height Difference	m	30						
Max. Piping Length	m	50						
Pipe Size (O.D)	Liquid	mm (Inch)	6.35 (1/4)	9.52 (3/8)				
	Gas	mm (Inch)	12.5 (1/2)	15.88 (5/8)				

Notes:

Rating conditions

*1 Cooling - Indoor : 27 / 19°C DB/WB, Outdoor: 35°C DB

*2 Cooling - Indoor : 29 / 19°C DB/WB, Outdoor: 46°C DB

*3 Noise Level is measured based on JIS standards.

Guaranteed Operating Range (Cooling)

Cooling	Indoor	Outdoor	
		SUY-KA18/24/30/36VA2	PUY-P45/60YKA2
Upper limit	32°CDB /23°CWB	52°CDB	52°CDB
Lower limit	21°CDB /15°CWB	18°CDB	-5°CDB

Control Technologies

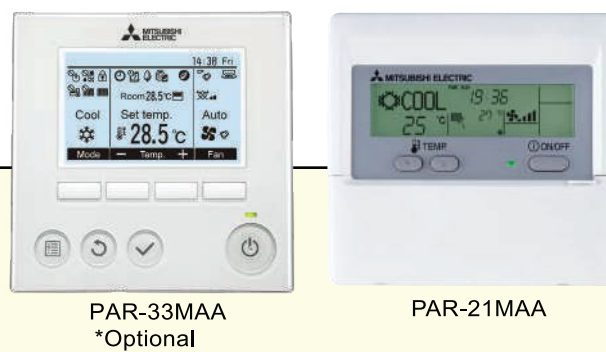

Advanced MA Remote Controller –
A Progressive Step in the Evolution
of Air Conditioning Control

Multi-language Display

Multi-language

Control panel operation in eight different languages

Choose the desired language, among the following languages.



Easy To Read & Easy To Use

Dot Liquid-crystal Display Adopted

The adoption of dot liquid-crystal display (LCD) technology and a large display screen for the control panel optimises visibility. Operation and control status are easily read at a glance.

Display Example [Operation Mode]

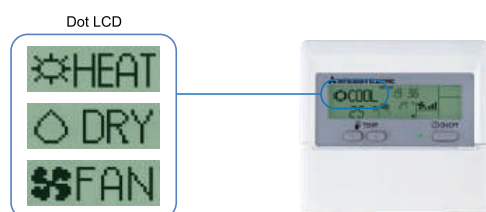

Energy-efficient Control

Operation Control Functions

Temperature Range Restriction

Air conditioner operation restricted to within a specified operating range

Set the upper and lower limits for the temperature range during operation. Excessive heating or cooling is prevented, leading to increased energy savings.

Cooling/Dry

(Setting example of minimum temp. in 25°C)

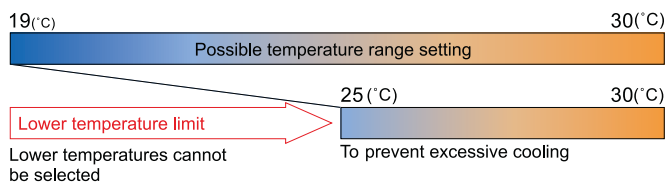

Recommended for **Office** **Restaurant**

The "Simple Timer"- starts/stops in units of 1 hour in a 72-hour period is set at the time of shipment from the factory. It can be changed to the "Auto-off Timer" function using the remote controller

Recommended for **Meeting room** **Changing room**

Only the administrator can change settings when using the Operation Lock mode.

Recommended for **Office** **School / Private school**

Public facility like public hall **Hospital** **Server room**

Auto-off Timer

Automatically turns off air conditioner

Set the time for the air conditioner to turn off automatically. The timer can be set in the range from 30 minutes up to 4 hours in 30-minute intervals.

Operation Lock

Prevent operation settings from being changed

Units can be set so that the operation mode cannot be changed. When "Operation Lock" is activated, new temperature setting commands are not accepted, thereby ensuring that the unit runs in the specified (locked in) temperature range. This promotes energy savings and prevents erroneous/ mischievous operation.

Weekly Timer

Introduced in response to market demand

Control temperature on a weekly basis

Temperature settings and On/Off control can be managed over a period of one week using the Weekly Timer. Up to eight setting patterns per calendar day are possible.

Setting the temperature 1°C higher for cooling and 1°C lower for heating leads to an energy savings of approximately 10%.

Setting Example (restaurant in summer time)

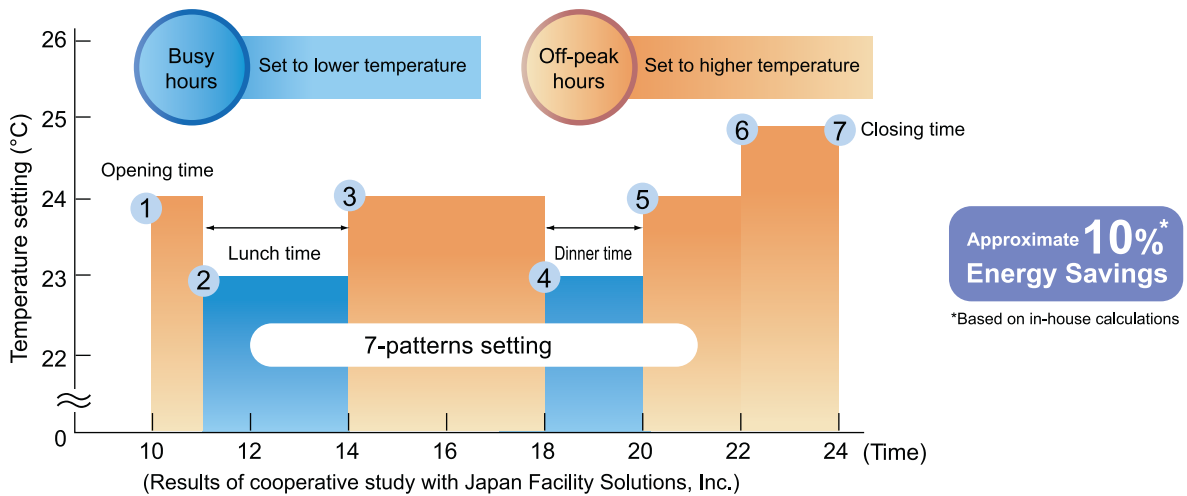

Rotation Back-up

Rotation, Back-up and 2nd Stage Cut-in Functions

(1) Rotation and Back-up Functions

Function Outline

- Main and sub units take turns operating according to a rotation interval setting.
- If one unit malfunctions, the other unit automatically begins operation (Back-up function)

System Image

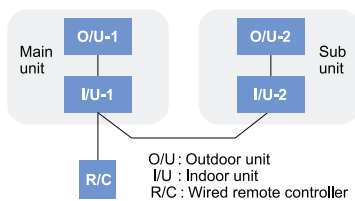

(2) 2nd Stage Cut-in Function

Function Outline

- Number of units operating is based on room temperature and predetermined settings.
- When room temperature rises above the desired setting, the standby unit starts (2-unit operation).
- When the room temperature falls 4°C below the predetermined setting, the standby unit stops (1-unit operation).

System Constraint

- This function is only available for rotation operation and when the back-up function is in cooling mode.

Operation Pattern

[Back-up function only]

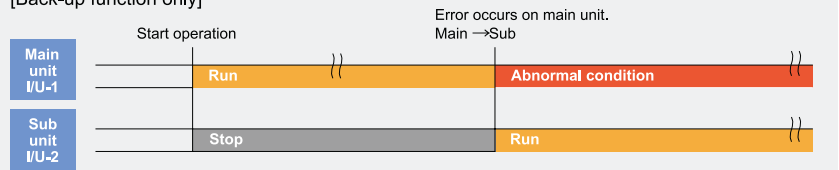

[Rotation function] & [Back-up function]

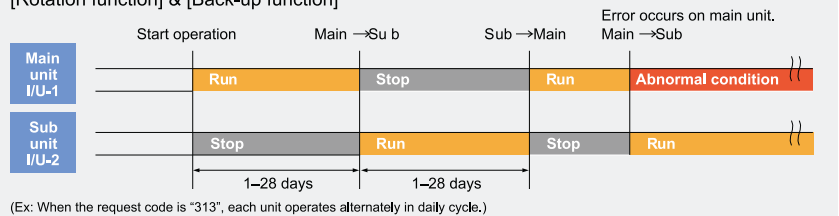

Operation Pattern

[2nd stage cut-in function]

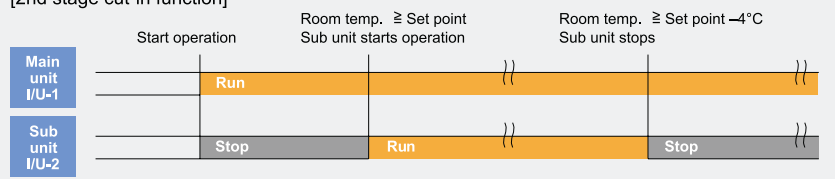

EXTERNAL DIMENSIONS

INDOOR UNIT

PEY-P18JAG, PEY-P24JAG, PEY-P30JAG, PEY-P36JAG, PEY-P45JAG

Unit : mm

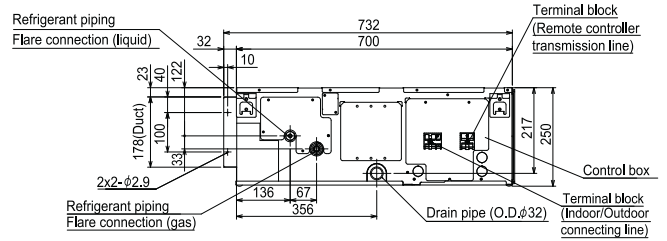
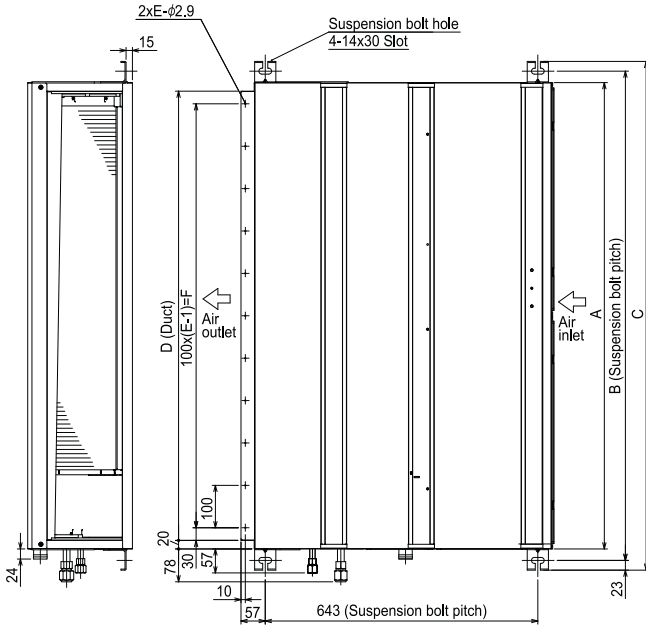

Models	A	B	C	D	E	F	G
PEY-P18JA	900	954	1000	860	9	800	858
PEY-P24JA	1100	1154	1200	1060	11	1000	1058
PEY-P30JA							
PEY-P36JA	1400	1454	1500	1360	14	1300	1358
PEY-P45JA							

PEY-P60GAG

Unit : mm

<Accessory>
 ·Pipe cover.....2pcs.
 (For dew condensation prevention of local piping and unit connection.)

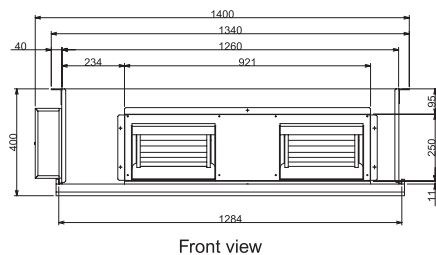
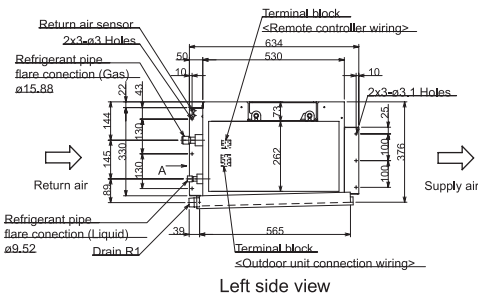
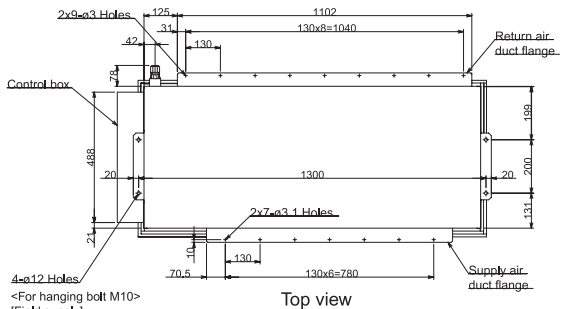
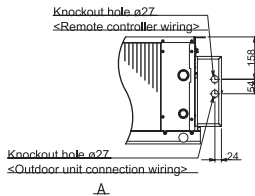

EXTERNAL DIMENSIONS

OUTDOOR UNIT

SUY-P18VA2

Unit : mm

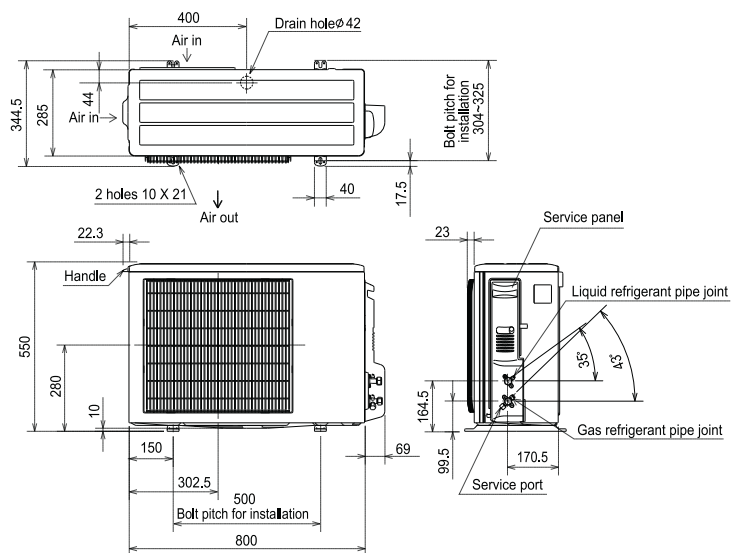

SUY-P24VA2, SUY-P30VA2, SUY-P36VA2

Unit : mm

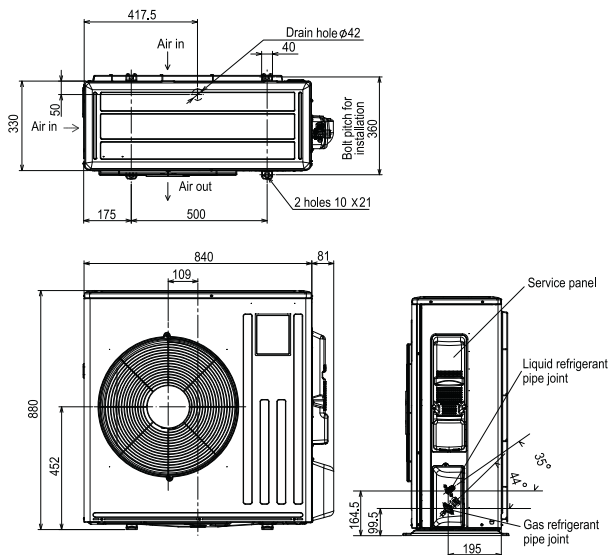

PUY-P45YKA2, PUY-P60YKA2



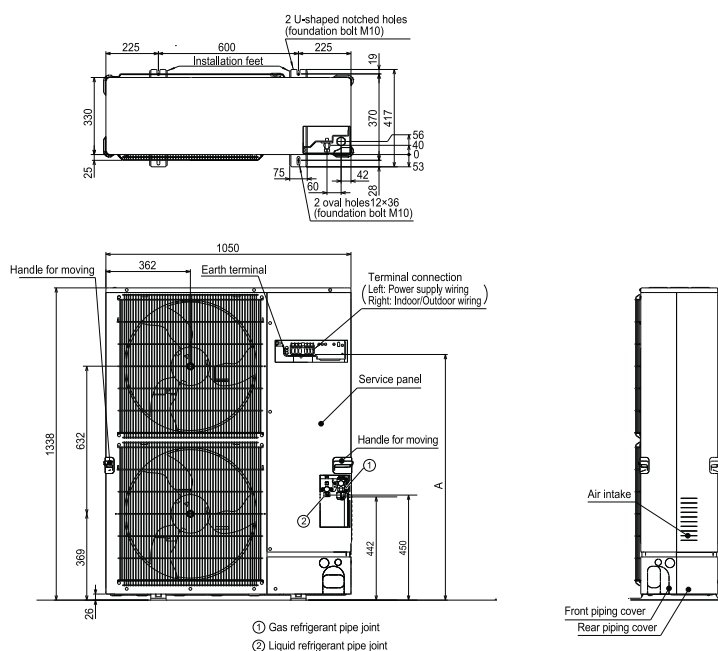

Unit : mm

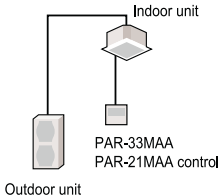

- ① Gas refrigerant pipe joint
- ② Liquid refrigerant pipe joint

System Control

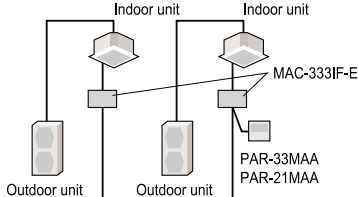
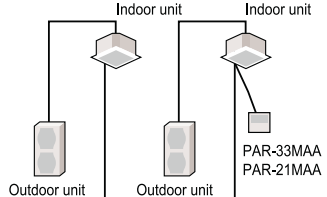
MAJOR SYSTEM CONTROLS

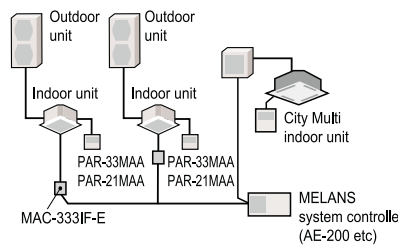
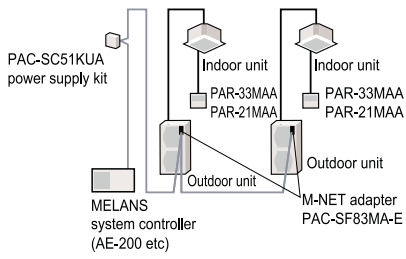
System Examples		
Indoor Unit	PEY Series indoor unit	
Outdoor Unit	SUY Series outdoor unit PUY Series outdoor unit	
 <p>PAR-33MAA Control PAR-21MAA Control</p>		
Details	Standard equipment (for indoor units compatible with wired remote controllers)	
Major Optional Parts Required	<ul style="list-style-type: none"> • PAR-33MAA (wired remote controller) • PAR-21MAA (wired remote controller) 	
 <p>System Group Control</p>		
Details	<ul style="list-style-type: none"> • One remote controller can simultaneously control multiple air conditioners with the same settings. • One remote controller can control up to 16 refrigerant systems. • Up to two remote controllers can be connected. 	
Major Optional Parts Required	<ul style="list-style-type: none"> • MAC-333IF-E (interface) • PAR-33MAA (wired remote controller) • PAR-21MAA (wired remote controller) 	<ul style="list-style-type: none"> • PAR-33MAA (wired remote controller) • PAR-21MAA (wired remote controller)
 <p>M-NET Connections</p>		
Details	<ul style="list-style-type: none"> • Group of air conditioners can be controlled by MELANS system controller (M-NET). 	
Major Optional Parts Required	<ul style="list-style-type: none"> • MAC-333IF-E (interface) • MELANS system controller 	<ul style="list-style-type: none"> • PAC-SF83MA-E (M-NET converter) • MELANS system controller

VARIATIONS FOR INDOOR UNITS (For SUY & PUY Series)

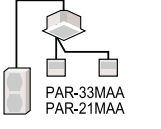
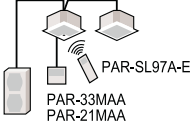
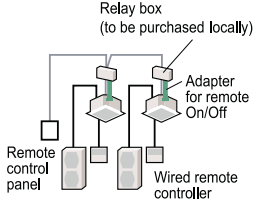
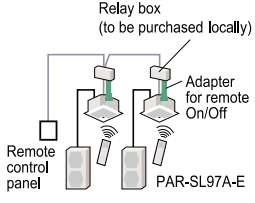
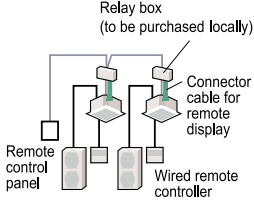
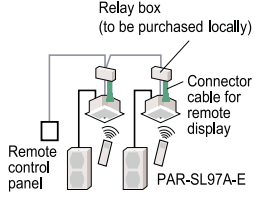
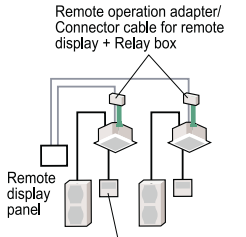
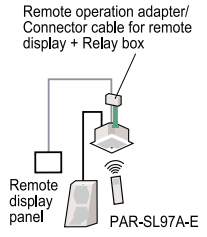
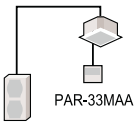
	System Examples		Details	Major Optional Parts Required
	Wired remote controller	Wireless remote controller		
<p>A 2-remote Controller Control</p> <p>With two remote controllers, control can be performed locally and remotely from two locations.</p>	 <p style="text-align: center;">* Set "Main" and "Sub" remote controllers.</p> <p style="text-align: center;">(Example of 1 : 1 system)</p>	 <p style="text-align: center;">* When using wired and wireless remote controllers</p> <p style="text-align: center;">(Example of simultaneous Twin-multi)</p>	<ul style="list-style-type: none"> Up to two remote controllers can be connected to one group. Both wired and wireless remote controllers can be used in combination. 	<ul style="list-style-type: none"> Wired remote controller PAR-33MAA/PAR-21MAA Wireless remote controller PAR-SL97A-E for PEY Wireless remote controller kit for PCY PAR-SL94B-E
<p>B Operation Control by Level Signal</p> <p>Air conditioner can be started/stopped remotely. In addition, On/Off operation by local remote controller can be prohibited/permitted.</p>	 <p style="text-align: center;">(Example of 1 : 1 system x 2)</p>	 <p style="text-align: center;">(Example of 1 : 1 system x 2)</p>	<ul style="list-style-type: none"> Operation other than On/Off (e.g., adjustment of temperature, fan speed and airflow) can be performed even when remote controller operation is prohibited. Timer control is possible with an external timer. 	<ul style="list-style-type: none"> Adapter for remote On/Off PAC-SE55RA-E Relay box (to be purchased locally) Remote control panel (to be purchased locally)
<p>C Operation Control by Pulse Signal</p>	 <p style="text-align: center;">(Example of 1 : 1 system x 2)</p>	 <p style="text-align: center;">(Example of 1 : 1 system x 2)</p>	<ul style="list-style-type: none"> The pulse signal can be turned on/off. Operation/emergency signal can be received at a remote location. 	<ul style="list-style-type: none"> Connector cable for remote display PAC-SA88HA-E/PAC-725AD (10 pcs. x PAC-SA88HA-E) Relay box (to be purchased locally) Remote control panel (to be purchased locally)
<p>D Remote Display of Operating Status</p> <p>Operating status can be displayed at a remote location.</p>	 <p style="text-align: center;">(Example of 1 : 1 system)</p>	 <p style="text-align: center;">(Example of Simultaneous Twin)</p>	<ul style="list-style-type: none"> Operation/emergency signal can be received at a remote location (when channeled through the PAC-SF40RM-E → no-voltage signal, when channeled through the PAC-SA88HA-E → DC 12V signal). 	<ul style="list-style-type: none"> Remote display panel (to be purchased locally) Connector cable for remote display PAC-SA88HA-E/PAC-725AD (10 pcs. x PAC-SA88HA-E) Relay box (to be purchased locally) Remote operation adapter PAC-SF40RM-E <p><small>*Unable to use with wireless remote controller</small></p>
<p>E Timer Operation</p> <p>Allows on/off operation with timer</p> <p><small>*For control by an external timer, refer to [B] Operation Control by Level Signal.</small></p>	 <p style="text-align: center;">(Example of 1 : 1 system)</p>		<ul style="list-style-type: none"> Weekly Timer: On/Off and up to 8 pattern temperatures can be set for each calendar day (initial setting). On/Off Timer: On/Off can be set once each within 72 hr in intervals of 5min. Auto-off Timer: Operation will stop after a preset time elapses. Set time can be changed from 30min to 4hr in 10min intervals. <small>*Simple Timer and Auto-off Timer cannot be used at the same time.</small> 	<p>Standard functions of PAR-33MAA</p>

Outdoor Unit Installation Location

- When installing a single outdoor unit

<S Series>

■ SUY-P18VA2

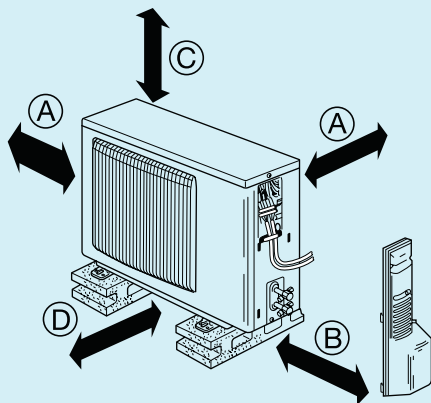

■ SUY-P24VA2

■ SUY-P30VA2

■ SUY-P36VA2

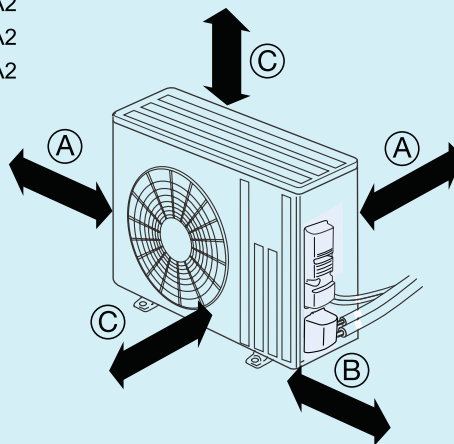

	SUY-P18VA2	SUY-P24, 30, 36VA2
(A)	100mm or more	
(B)	350mm or more	
(C)	100mm or more	500mm or more
(D)	200mm or more	—

<P Series>

■ PUY-P45YKA2

■ PUY-P60YKA2

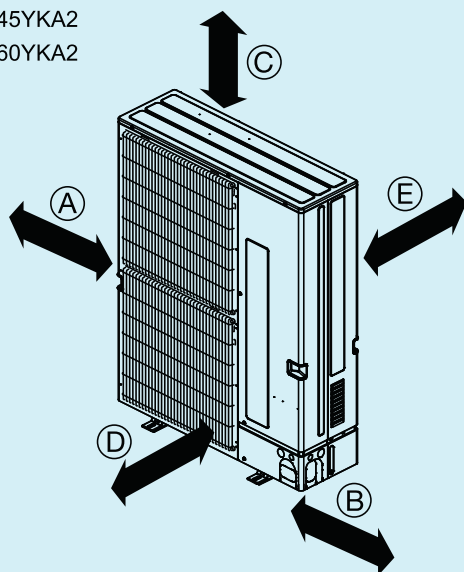

	PUY-P45,60 YKA2
(A)	15mm or more
(B)	15mm or more
(C)	Free
(D)	1,000mm or more
(E)	150mm or more

[Notice]

If there is any obstruction around the unit, check the condition details in the Data Book.

Optional Parts

Part name	Model name	Application name
M-NET and Terminal interface	MAC-333IF-E	All indoor units
Wireless remote controller	PAR-SL97A-E	PEY-P
Wireless remote controller signal receiver	PAR-SA9CA-E	PEY-P
Filter box	PAC-KE92TB-E	PEY-P18
	PAC-KE93TB-E	PEY-P24
	PAC-KE94TB-E	PEY-P30/36/45/60
Remote On/Off adaptor	PAC-SE55RA-E	All indoor units
Remote operation adaptor	PAC-SF40RM-E	All indoor units
Remote sensor	PAC-SE41TS-E	All indoor units
Connector cable for remote display	PAC-SA88HA-E	All indoor units
Wired remote controller	PAR-33MAA	All indoor units
	PAR-21MAA	All indoor units
Multiple remote controller adaptor	PAC-725AD	All indoor units
Air discharge guide	MAC-881SG	SUY-P18
	MAC-886SG-E	SUY-P24/30/36
Distribution pipe	MSDD-50TR-E	PUY-P60
Joint pipe	PAC-SG73RJ-E	PUY-P45/60
	PAC-SG75RJ-E	PUY-P45/60
Filter dryer for liquid pipe	PAC-SG82DR-E	PUY-P45/60
Air outlet guide	PAC-SH96SG-E	PUY-P45/60
Air protection guide	PAC-SH95AG-E	PUY-P45/60
Drain socket	PAC-SG61DS-E	PUY-P45/60
Centralized drain pan	PAC-SH97DP-E	PUY-P45/60
M-Net converter	PAC-SF83MA-E	PUY-P45/60
Control/Service tool	PAC-SK52ST	PUY-P45/60
External/Input adapter	PAC-SC36NA-E	PUY-P45/60

MITSUBISHI ELECTRIC MULTIPLE SPLIT TYPE AIR CONDITIONERS



for a greener tomorrow

Eco Changes is the Mitsubishi Electric Group's environmental statement, and expresses the Group's stance on environmental management. Through a wide range of businesses, we are helping contribute to the realization of a sustainable society.

Warning

- Do not use refrigerant other than the type indicated in the manuals provided with the unit and on the nameplate.
 - Doing so may cause the unit or pipes to burst, or result in explosion or fire during use, repair, or at the time of disposal of the unit.
 - It may also be in violation of applicable laws.
 - MITSUBISHI ELECTRIC CORPORATION cannot be held responsible for malfunctions or accidents resulting from the use of the wrong type of refrigerant.
- Our air conditioning equipment and heat pumps contain a fluorinated greenhouse gas, R410A.

MITSUBISHI ELECTRIC CORPORATION

HEAD OFFICE: TOKYO BLDG., 2-7-3 MARUNOUCHI, CHIYODA-KU, TOKYO 100-8310, JAPAN
<http://Global.MitsubishiElectric.com/>